

# RUNDFLEX

Continuous and quickly adjustable circular formwork for radii greater than 1.00 m

Product Brochure

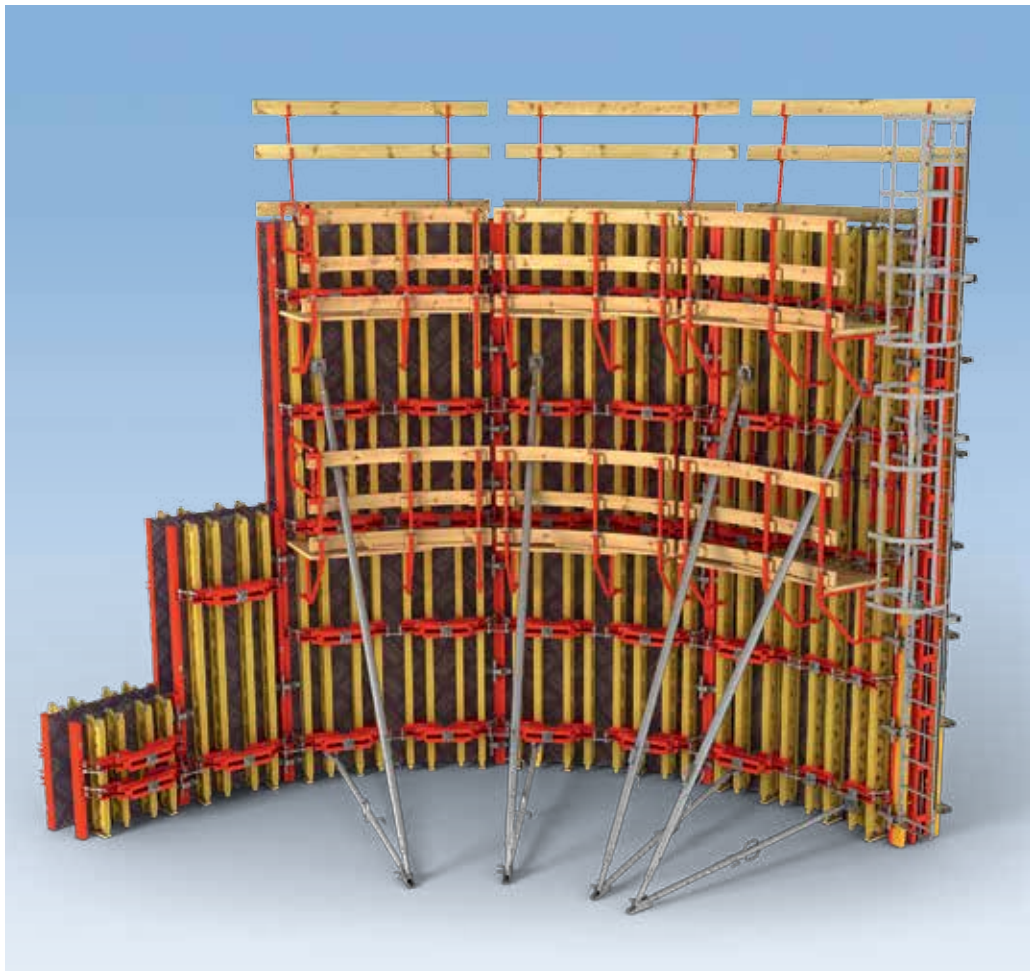

# Content

|   |  |
|---|--|
| <b>RUNDFLEX system advantages</b>   | <b>System overview</b>   |
| 4 The continuous and quickly adjustable circular formwork for diameters greater than 1.00 m | 12 RUNDFLEX at a glance  |
| 6 Low installation effort   | <b>Standard applications</b>   |
| 8 Fast adjustment   | 14 Height extensions, working and concreting platform, guidelines for constructing a radius template |
| 10 Extremely variable   | 16 Push-pull props, stopend formwork, T-junctions, straight wall connection                          |

**Edition 07 | 2016**

**Publisher**

**PERI GmbH**  
**Formwork Scaffolding Engineering**  
Rudolf-Diesel-Strasse 19  
89264 Weissenhorn  
Germany  
Tel. +49 (0)7309.950-0  
Fax +49 (0)7309.951-0  
info@peri.com  
www.peri.com

|    |                         |
|----|-------------------------|
|    | <b>Project examples</b> |
| 18 | RUNDFLEX in use         |

|    |                            |
|----|----------------------------|
|    | <b>Components</b>          |
| 22 | RUNDFLEX system components |

#### **Important notes**

Without exception, all current safety regulations and guidelines must be observed in those countries where our products are used.

The photos shown in this brochure feature construction sites in progress. For this reason, safety and anchor details in particular cannot always be considered as conclusive or final. These are subject to the risk assessment carried out by the contractor.

In addition, computer graphics are used which are to be understood as system representations. For ensuring a better understanding, these and the detailed illustrations shown have been partially

reduced to certain aspects. The safety installations which have possibly not been shown in these detailed descriptions must nevertheless be available. The systems or items shown might not be available in every country.

Safety instructions and load specifications are to be strictly observed at all times. Modifications and deviations require a separate static proof.

The information contained herein is subject to technical changes in the interests of progress. Errors and typographical mistakes reserved.







## RUNDFLEX

The continuous and quickly adjustable circular wall formwork for radii with diameters greater than 1.00 m

**The RUNDFLEX Circular Wall Formwork provides pre-assembled standard panels for circular walls which can be quickly adjusted without any complicated panel modifications in order to achieve the required radius. Therefore, the circular formwork is particularly effective for realizing structures such as wastewater treatment plants, spiral ramps for multi-storey parking facilities, silos or oriels where radii are constantly changing.**

This results in low utilization rates per formwork element and radius. In order to be able to efficiently form these

structures, formwork elements must be quickly and flexibly adjusted to suit different radii. RUNDFLEX solves this problem with standard elements and fast radii adjustment. Material costs and time requirements can be significantly reduced with RUNDFLEX – even for radii of 1.00 m.

With a permissible fresh concrete pressure of 60 kN/m<sup>2</sup>, RUNDFLEX also allows high concreting speeds.



### Low installation effort

through pre-assembled units and the proven BFD Alignment Coupler



### Fast and precise adjustment

through a simple adjustment procedure by means of a template and spindles



### Extremely variable

through the flexible adjustment of wall internal radii of 1.00 m and larger – also for complicated geometries

## Low installation effort

Fast forming operations through pre-assembled standard elements and the proven BFD Alignment Coupler



**RUNDFLEX elements are pre-assembled at the assembly hall and are available in 3 different panel widths and 6 panel heights.**

In order to reduce transportation space to a minimum, elements are bundled together in a straight form and then adjusted on the construction site to suit the required radius.





**Element connections and required compensations up to 10 cm are carried out quickly and simply with the BFD Alignment Coupler.**

When connecting the elements, ensure that the elements (external and internal) are aligned on their axis.

For the use of filler timbers up to a maximum of 10 cm between the external and internal elements, corresponding tables are available. For smaller radii, filler timbers are to be cut to a suitable trapezoidal shape.

The alignment coupler can also be used for connecting RUNDFLEX with the elements of other formwork systems (e.g. with TRIO).

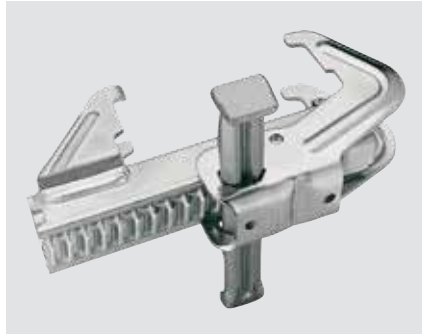

For connecting the elements, the BFD Alignment Coupler ensures flush, aligned and tight panel connections.



The BFD Alignment Coupler connects the panels; the Adjusting Spindle is only required when the element units are moved.

**Elements for radii  $\geq 4.00$  m**

Plywood: 21 mm

**External elements**

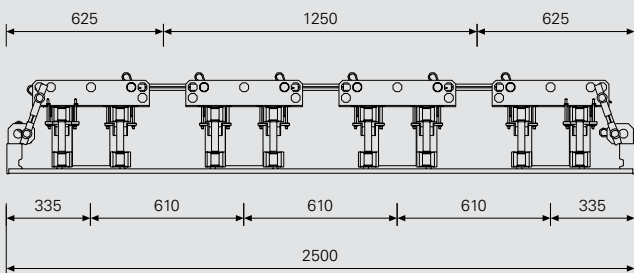

**Internal elements**

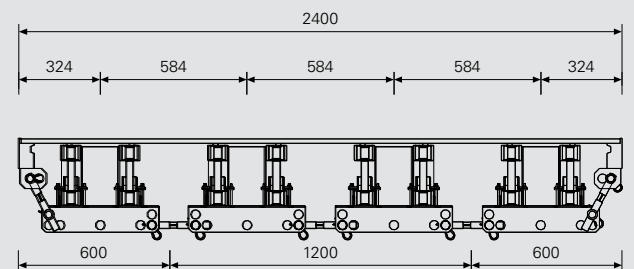

**Elements for radii  $\geq 2.50$  m**

Plywood: 18 mm

**External elements**

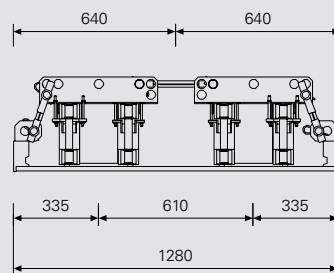

**Internal elements**

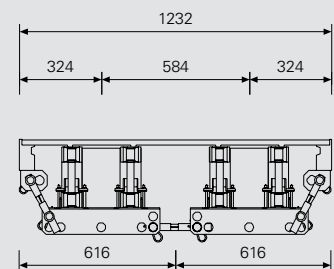

**Elements for radii  $\geq 1.00$  m**

Plywood: 2 x 9 mm

**External elements**

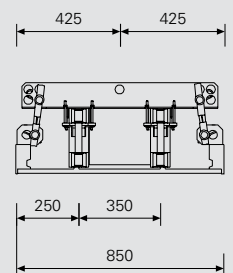

**Internal elements**

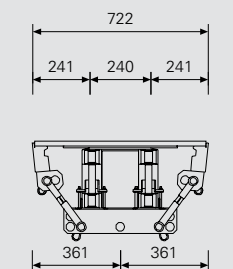

## Fast and precise adjustment

Simple setting of the radii with adjustable spindles and templates

**The pre-assembled RUNDFLEX elements can be quickly adapted to changes in the radii with a minimum of effort.**

By means of the self-cleaning Adjusting Spindles, the formwork is easily adjusted to fit the required curvature using a Ratchet Spanner and template. PERI delivers the ready-to-use customized radii templates to the construction site. Complicated geometries with constantly changing radii are also quickly and easily formed in this way using RUNDFLEX.

In the process, the adjustable spindles are installed so that the yellow chromated parts are always facing the same direction. Through the same turning direction in each case, the adjusting procedure is uncomplicated and fast.



Checking the required curvatures is carried out by placing the radius template on the formwork girders.

**How it's done**

Radii adjustment basically begins with the spindles in the middle of the element and then work outwards in a uniform sequence.

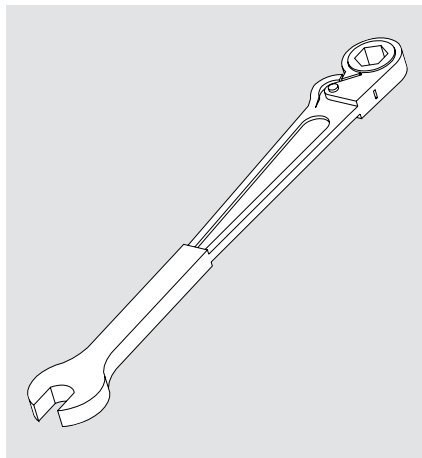

The "combi" Ratchet Spanner for quick adjustment of RUNDFLEX elements.



The adjustable spindle for adjusting the edge profile is also operated by means of the "combi" Ratchet Spanner.

## Extremely variable

Flexible adjustment of wall internal radii of 1.00 m and larger – also for complicated geometries



**RUNDFLEX is an enormously versatile and adaptable circular wall formwork. The system provides a solution for virtually any challenge in connection with curvatures, changing radii, roundings and arches.**

Through the possible combination of RUNDFLEX with other formwork systems, complicated ground plans can also be cost-effectively realized. Using the BFD Alignment Coupler, RUNDFLEX elements can be effortlessly combined with TRIO Panel Formwork.

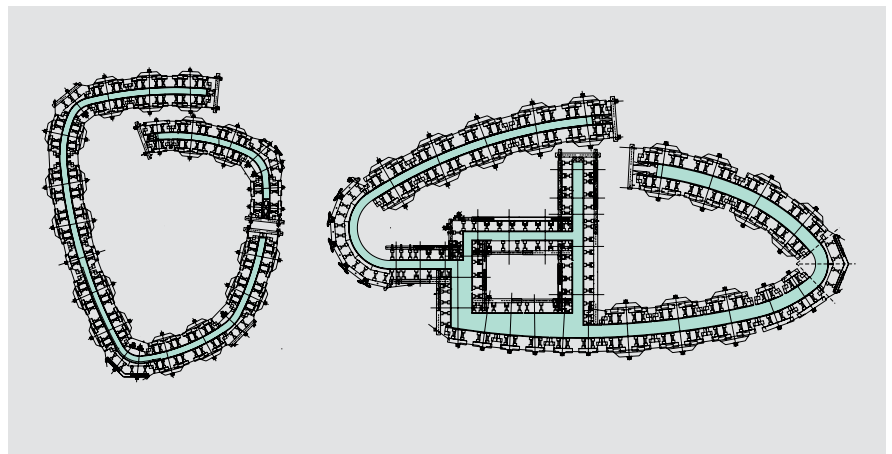

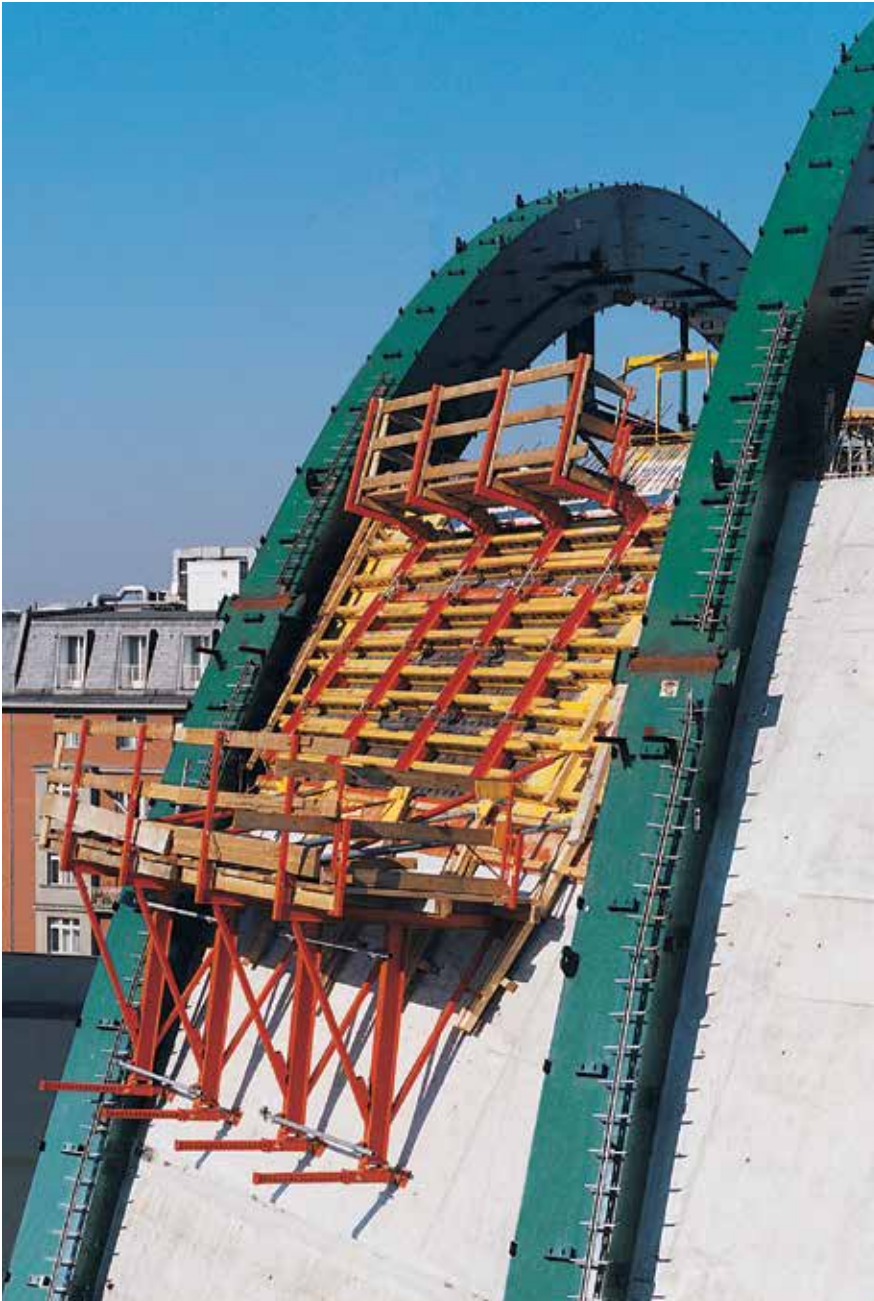

**For applications such as tunnel portals or other arched forms, RUND FLEX can also be used horizontally.**

Elliptically-shaped tunnel portal with RUND FLEX elements and accessories from the VARIO programme. The problem of constantly changing radii and inclination was solved by means of conically-cut filler timbers.



## RUNDFLEX at a glance

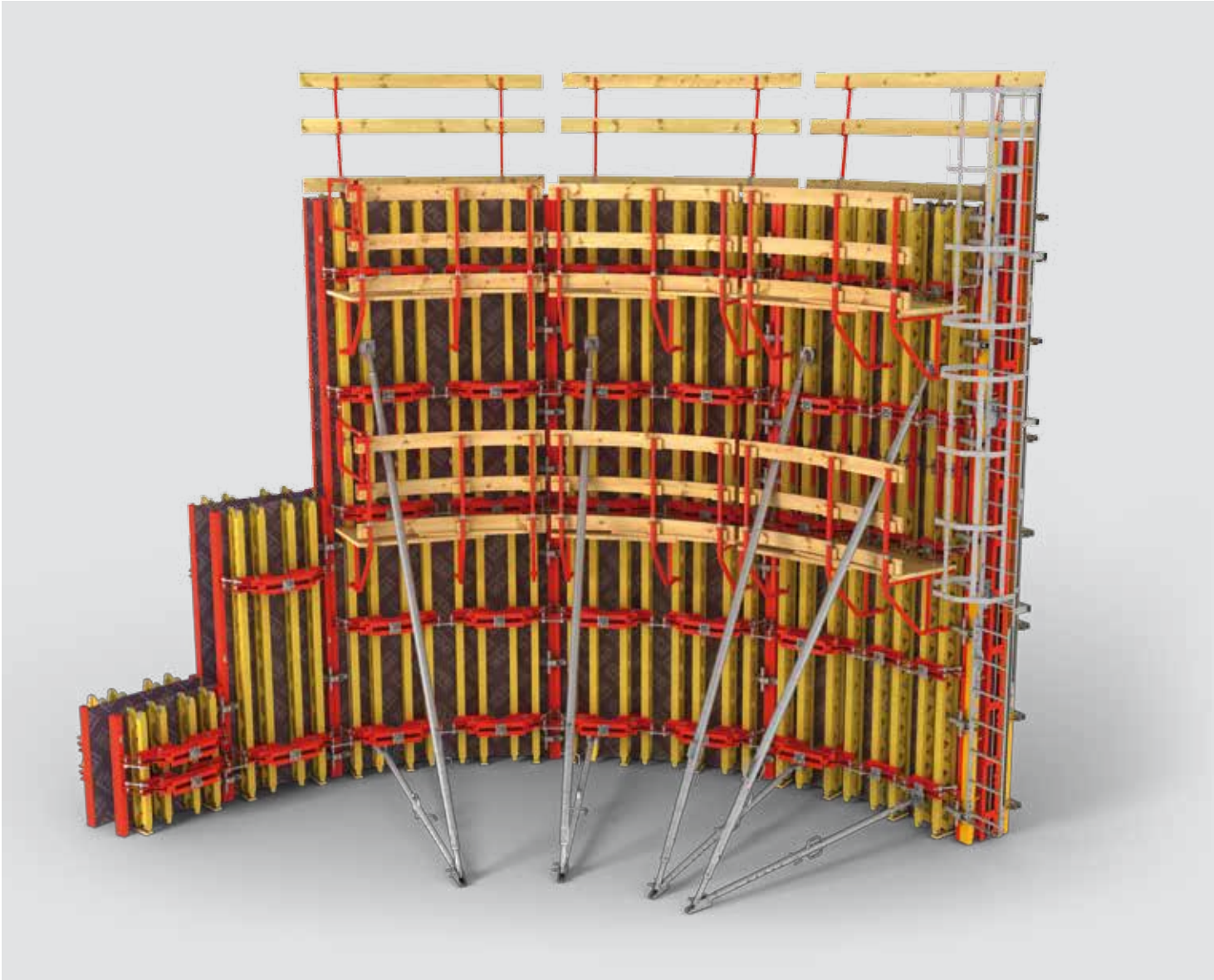

T-Junctions

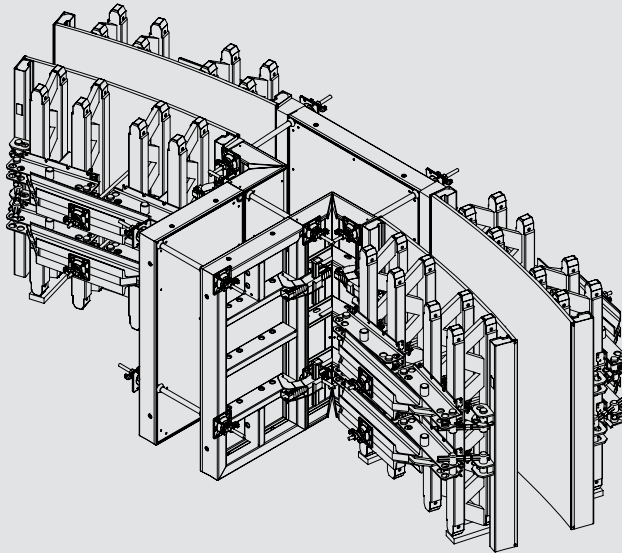

Straight wall connection

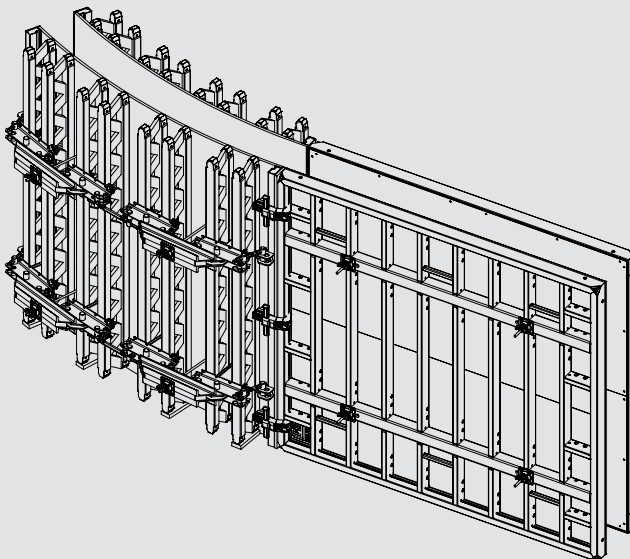
**A well-rounded success**

RUNDFLEX provides a fast solution in the system for all standard applications. The right accessories are available for height extensions and stopend formwork as well as wall connections. Last but not least, the portfolio includes system supplements for realizing safe working and concreting platforms on the formwork.

# Height extensions, working and concreting platform, guidelines for constructing a radius template

## Height extensions



**RUNDFLEX elements can be extended in 60 cm increments.**

RUNDFLEX elements can be extended horizontally up to a length of 7.80 m and then erected as one unit. For extending in a vertical position as well as transporting vertically, higher units are also possible.

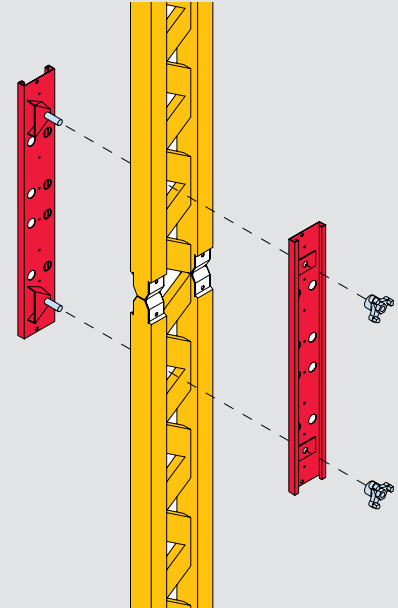

Horizontal extensions take place in a straight line; one extension splice is to be mounted per girder joint.

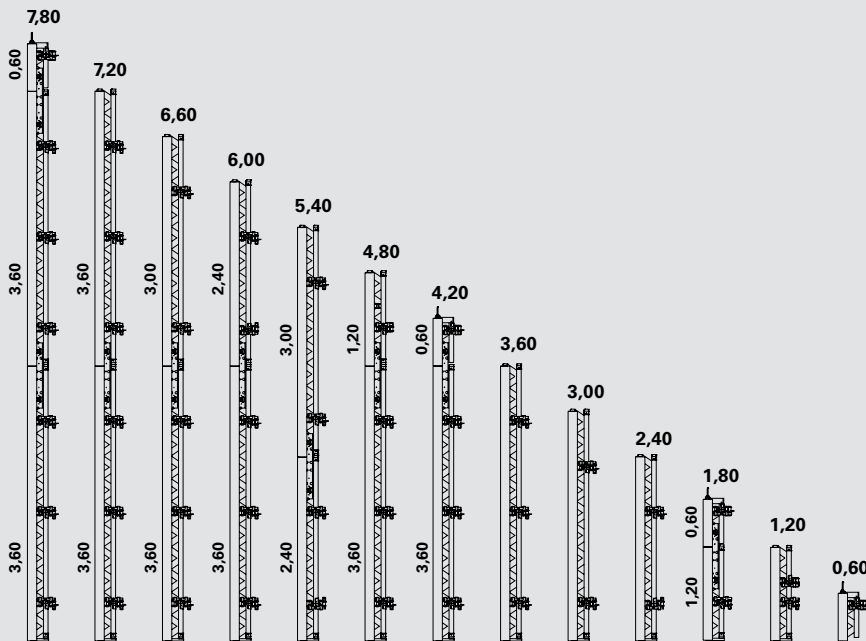



## Working and Concreting Platform

**For the installation of safe working and concreting scaffold, RUNDFLEX provides all required system components.**

The scaffold bracket can be mounted at each nodal point of the Lattice Girder GT 24. Platform lining, side and rear protection are supplemented in accordance with respective national regulations.

Assembly of components takes place on a horizontally-positioned element. In addition, an access ladder can be mounted to the first and last element of a set of formwork.



## Guidelines for constructing a radius template

### For the external formwork

Radius = concrete radius + 26.5 cm (for 21 mm plywood thickness and 4 mm formlining strip on GT 24 girders).

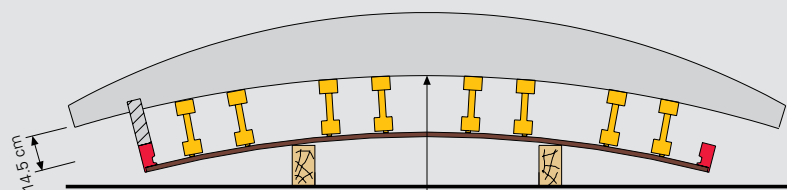

Radius template for elements  
A 250 outside / I 240 inside,  
A 128 outside / I 123 inside

$$R_a = \text{concrete radius} + 26.5 \text{ cm}$$

### For the internal formwork

Radius = concrete radius - 26.5 cm (for 21 mm plywood thickness and 4 mm formlining strip on GT 24 girders).

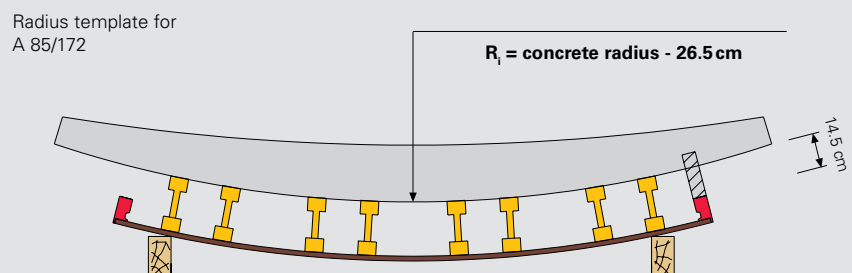

Radius template for  
A 85/172

$$R_i = \text{concrete radius} - 26.5 \text{ cm}$$

# Push-pull props, stopend formwork, T-junctions, straight wall connections

## Push-pull props

**RUNDFLEX elements are supported with push-pull props and kickers.**

Girder headpieces allow push-pull props and kickers to be fixed on Lattice Girders GT 24 as well as in the area of the extension splices. Push-pull props and kickers are mounted by means of pins and cotter pins.

Push-pull props are also mounted on horizontally-positioned elements.

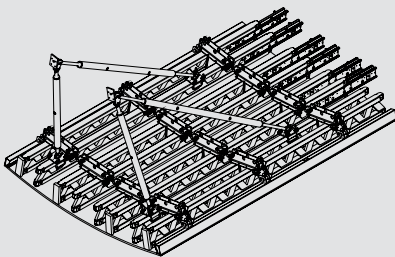

## Stopend formwork

**Stopend formwork can be realized with and without continuous reinforcement.**

TRIO Stopend Panels – with and without water bar installation – are suitable for the stopend formwork of RUNDFLEX elements. Alternatively, stopend formwork complete with steel walers is provided by the contractor, or SRS Circular Columns can also be used as stopend formwork.

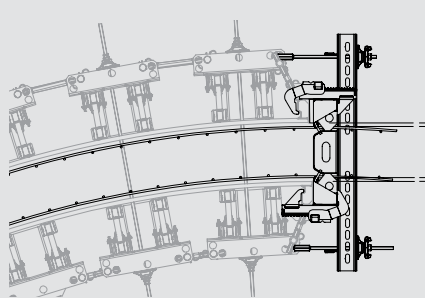

Stopend formwork for RUNDFLEX with the TRIO Stopend Panel and continuous reinforcement.

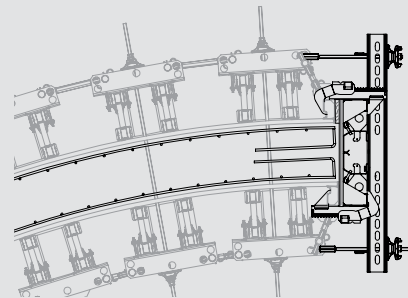

Stopend formwork for RUNDFLEX with the TRIO Stopend Panel without continuous reinforcement.

## Connecting panel formwork

**The edge profile of the RUNDFLEX element allows PERI panel formwork to be connected to the circular formwork by means of BFD-suitable profiles.**

In this way, the transition to straight wall sections can be quickly and easily realized. Depending on the radius, the use of filler timbers may be required.

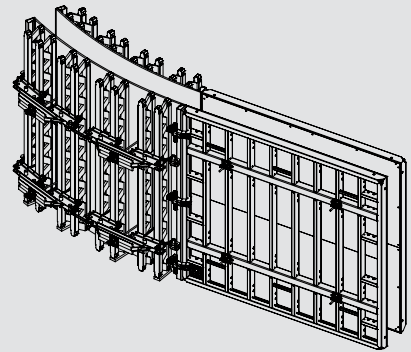

Straight outgoing walls can also be easily realized. For normal wall thicknesses, a 90 cm wide frame panel is used for this purpose on the outer side of the formwork; on the inner side, two articulated corners or two internal corners are connected.

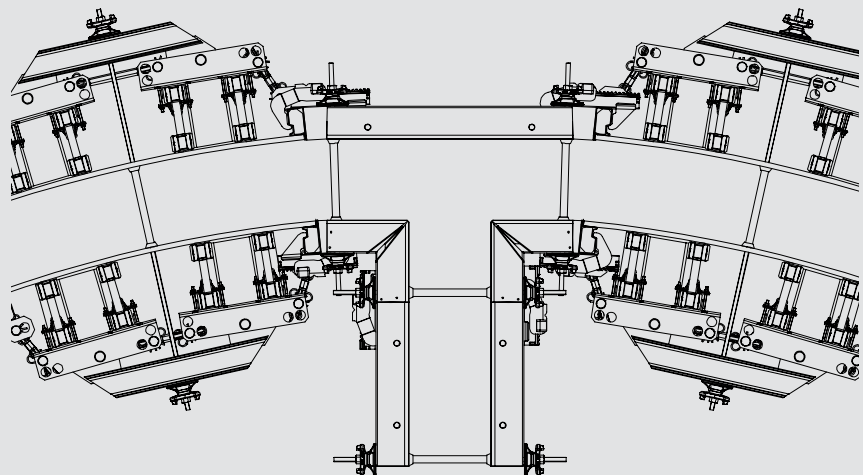

## RUNDFLEX in use



### **MAC Museum, Singen, Germany**

With the Museum Art & Cars (MAC), the town of Singen in Baden-Württemberg has a unique and unmistakable museum building. In the style of the nearby Hohentwiel fortress, the

walls and roof landscape of the structure are repeatedly curved. In addition to the range of specific architectural requirements, high demands were placed on the static through the earthquake-resistant design of the museum. For the complex shapes, RUNDFLEX

proved itself to be the optimal solution. With the easily adaptable formwork system, the various merging radii were continuously and quickly realized without any problems.



## RUNDFLEX in use



Text-book execution: the in-situ concrete curvatures feature variable radii.



Exceptional challenge in housing construction: reinforced concrete walls with constantly changing radii and offset residential floors.

### Secondary School, Bochum, Germany

The new secondary school in Bochum, with approx. dimensions of 125 m x 70 m, required a tight schedule with a construction period of only seven months. The three-storey complex consists of two interlocking, ring-shaped structures. In the process, the radii of the two rings continuously change.

For forming the multiple curved shape of the structure, the continuous adjustment option of the RUNDFLEX elements proved to be enormously time saving. The fact that the TRIO Panel Formwork could be easily and simply connected for the straight wall sections, also accelerated formworking operations.

### Single-family house, Tuttlingen, Germany

The basement and residential floors of this single-family house consist almost entirely of circular-shaped walls with constantly changing radii and offset living areas. Just the 2.75 m high basement walls alone feature ten different radii and were formed with RUNDFLEX and TRIO in seven cycles.

The RUNDFLEX elements could be accurately and quickly adjusted on the construction site for the next cycle. At the same time, element connections with the BFD Alignment Coupler system allowed timber compensations up to 10 cm thick as well as the combination with the TRIO Panel Formwork.



RUNDFLEX also for architectural concrete: depending on requirements, the very best surface qualities can also be achieved with the circular formwork.

### **Arena Stage, Washington, USA**

The refurbishment and expansion of the Arena Stage Theater includes, among other things, an elliptically-shaped structure whose walls feature 4° inclinations and reach a height of 23 m. Furthermore, very high architectural concrete requirements were placed on the surfaces of these walls.

RUNDFLEX formwork was used which included high-grade formlining. For the higher-positioned areas, the construction team combined the wall formwork with the CB 240 Climbing System. The units were climbed from concreting cycle to cycle by crane.



RUNDFLEX in use for the shaft of a pump station with a diameter of 25 m.

### **Pump Station, Preston, England**

As part of a major project for improving the sewage system in Preston, a central pumping station was built in Penwortham which, after it was completed, directs rain water among other things to the wastewater treatment plant in Clifton Marsh.

The excavated shaft for the station has a diameter of over 25 m and a depth of 36 m. For the shaft mantle and dividing walls, 5,000 m<sup>2</sup> of heavily reinforced concrete was used. The formwork solution for the mantle of the shaft consisted of a combination of RUNDFLEX and TRIO elements.

| Item no. | Weight kg |
|----------|-----------|
| 021800   | 127.000   |
| 021820   | 176.000   |
| 102856   | 231.000   |
| 126073   | 292.000   |
| 021840   | 342.000   |
| 021400   | 422.000   |
| 021880   | 513.000   |

- Outside Panels A 250**
- Outside Panel A 250 x 60**
- Outside Panel A 250 x 120**
- Outside Panel A 250 x 120 2R**
- Outside Panel A 250 x 180**
- Outside Panel A 250 x 240**
- Outside Panel A 250 x 300**
- Outside Panel A 250 x 360**

Ready-to-use formwork panel for circular structures.

**Note**

Element without distribution waler.  
 Panel A 250 x 60 and A 250 x 180 complete with crane eye on the left and on the right side.

**Technical Data**

Minimum radius 4.0 m. Plywood 21 mm.  
 Permissible load-bearing point capacity 700 kg with crane sling angle  $\leq 15^\circ$ .

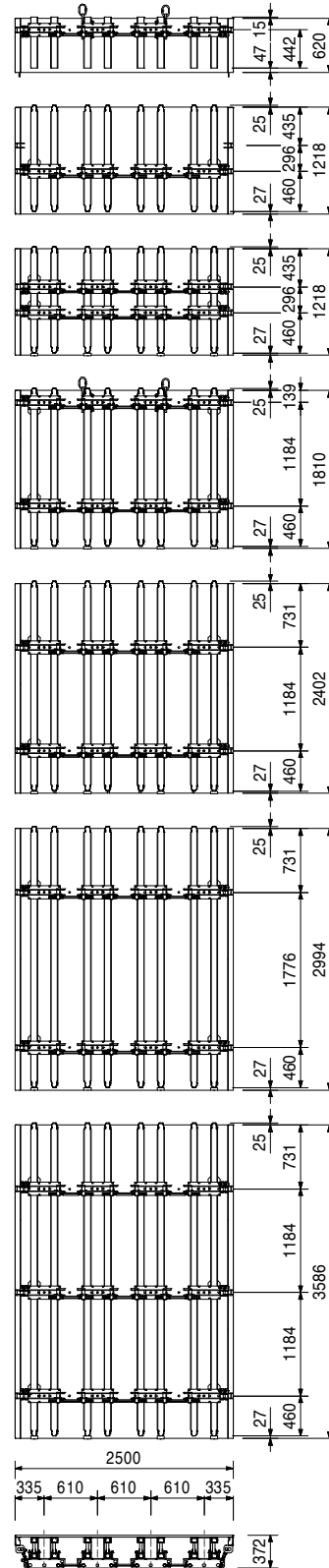
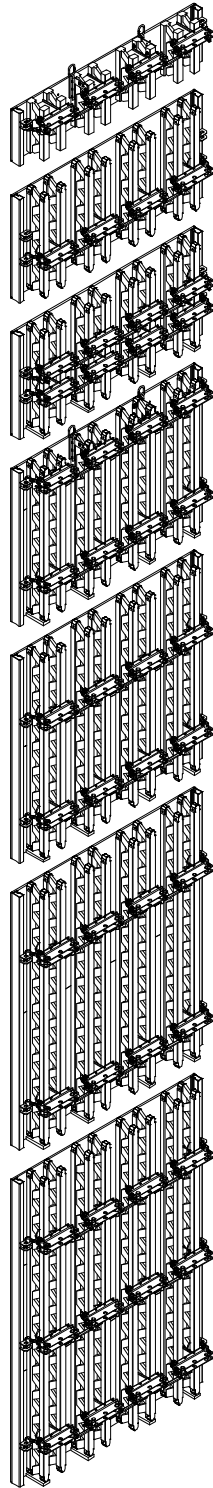



| Item no. | Weight kg |
|----------|-----------|
| 021810   | 124.000   |
| 021830   | 169.000   |
| 102855   | 219.000   |
| 126043   | 283.000   |
| 021850   | 335.000   |
| 021410   | 408.000   |
| 021890   | 499.000   |

- Inside Panels I 240**
- Inside Panel I 240 x 60**
- Inside Panel I 240 x 120**
- Inside Panel I 240 x 120 2R**
- Inside Panel I 240 x 180**
- Inside Panel I 240 x 240**
- Inside Panel I 240 x 300**
- Inside Panel I 240 x 360**

Ready-to-use formwork panel for circular structures.

**Note**

Element without distribution waler.  
 Panel I 240 x 60 and I 240 x 180 complete with crane eye on the left and on the right side.

**Technical Data**

Minimum radius 4.0 m. Plywood 21 mm.  
 Permissible load-bearing point capacity 700 kg with crane sling angle  $\leq 15^\circ$ .

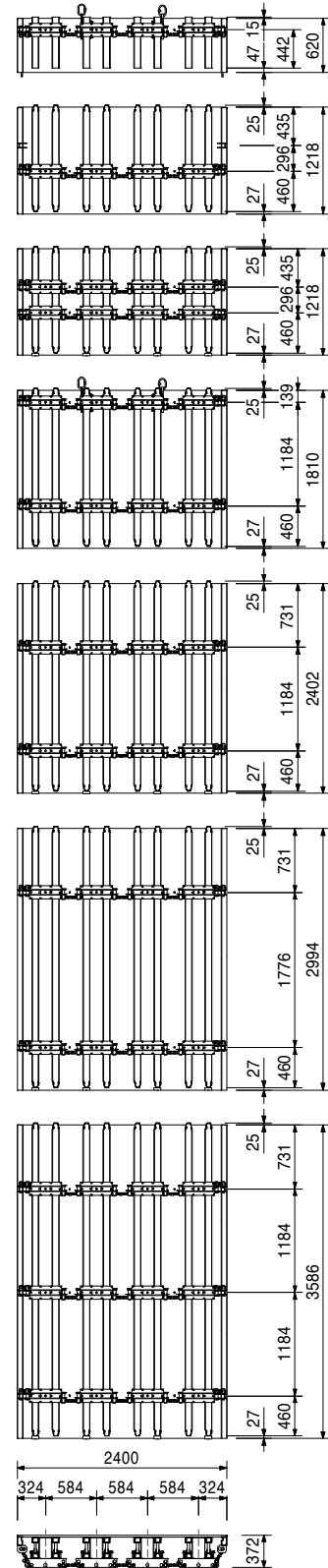
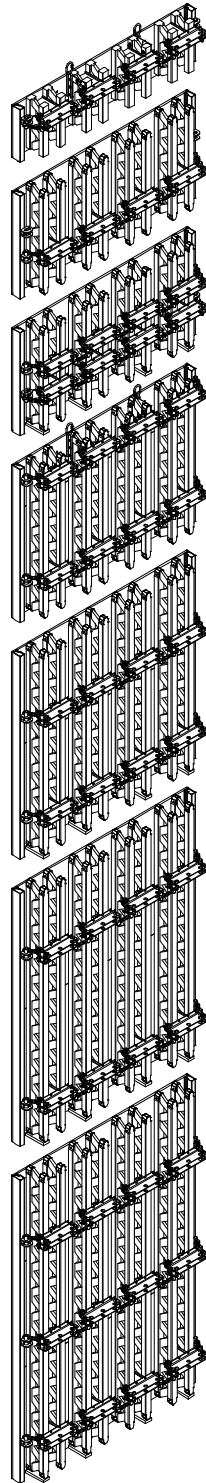

| Item no. | Weight kg |
|----------|-----------|
| 021900   | 72.500    |
| 021920   | 99.000    |
| 102854   | 128.000   |
| 126075   | 167.000   |
| 021940   | 194.000   |
| 021420   | 243.000   |
| 021960   | 289.000   |

- Outside Panels A 128**
- Outside Panel A 128 x 60**
- Outside Panel A 128 x 120**
- Outside Panel A 128 x 120 2R**
- Outside Panel A 128 x 180**
- Outside Panel A 128 x 240**
- Outside Panel A 128 x 300**
- Outside Panel A 128 x 360**

Ready-to-use formwork panel for circular structures.

**Note**

Element without distribution waler.  
 Panel A 128 x 60 und A 128 x 180 complete with crane eye on the left and on the right side.

**Technical Data**

Minimum radius 2.5 m. Plywood 18 mm.  
 Permissible load-bearing point capacity 700 kg with crane sling angle  $\leq 15^\circ$ .

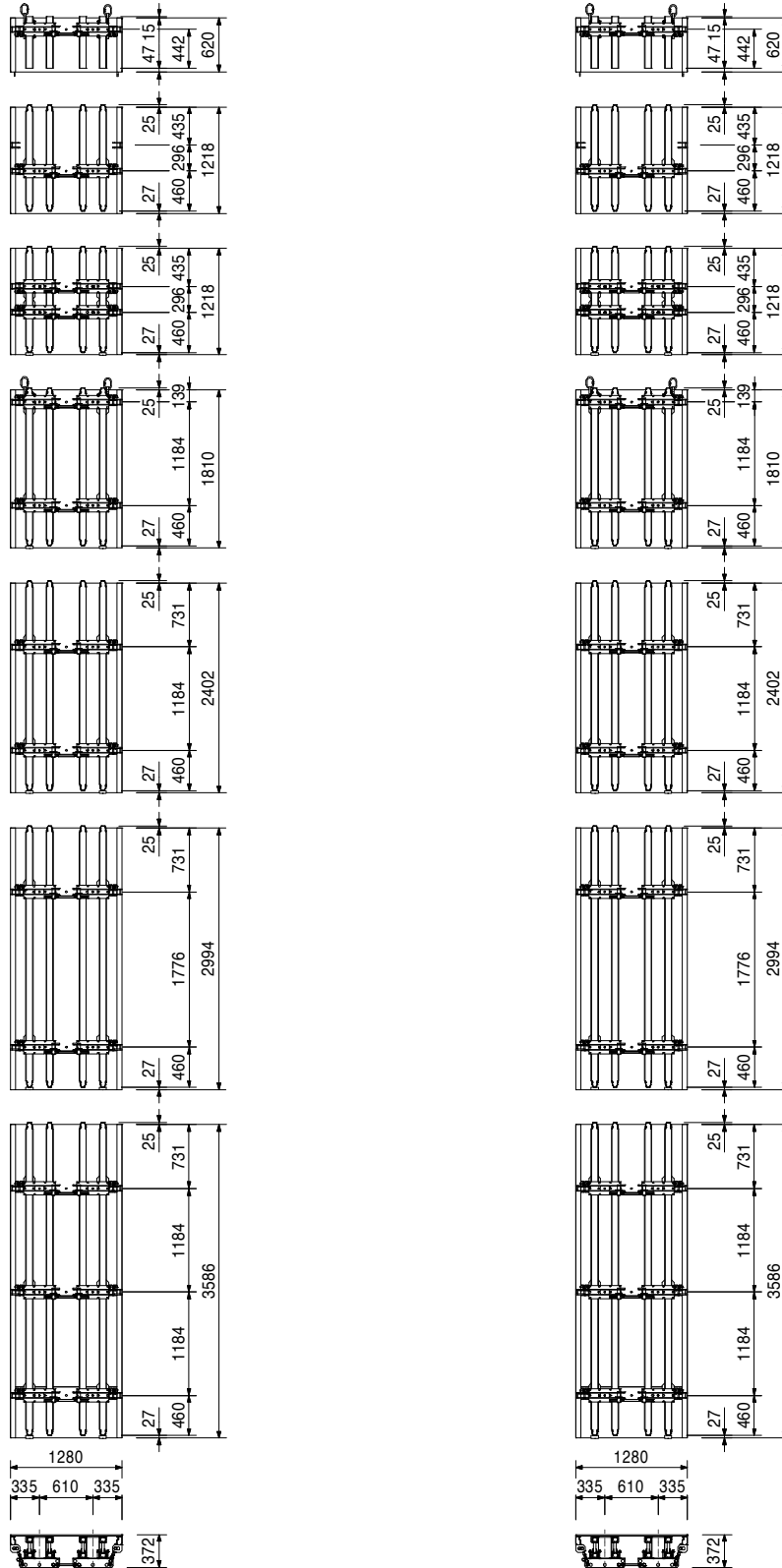

| Item no. | Weight kg |
|----------|-----------|
| 021910   | 71.200    |
| 021930   | 95.300    |
| 102853   | 122.000   |
| 126067   | 160.000   |
| 021950   | 186.000   |
| 021430   | 235.000   |
| 021970   | 275.000   |

- Inside Panels I 123**
- Inside Panel I 123 x 60**
- Inside Panel I 123 x 120**
- Inside Panel I 123/120 2R**
- Inside Panel I 123 x 180**
- Inside Panel I 123 x 240**
- Inside Panel I 123 x 300**
- Inside Panel I 123 x 360**

Ready-to-use formwork panel for circular structures.

**Note**

Element without distribution waler.  
 Panel I 123 x 60 and I 123 x 180 complete with crane eye on the left and on the right side.

**Technical Data**

Minimum radius 2.5 m. Plywood 18 mm.  
 Permissible load-bearing point capacity 700 kg with crane sling angle  $\leq 15^\circ$ .

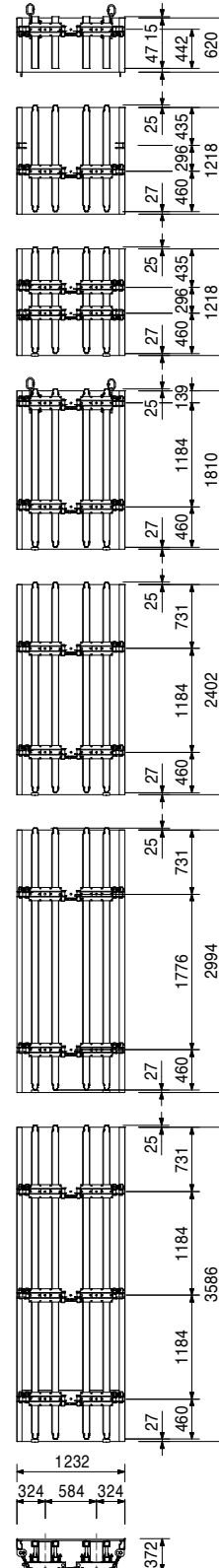
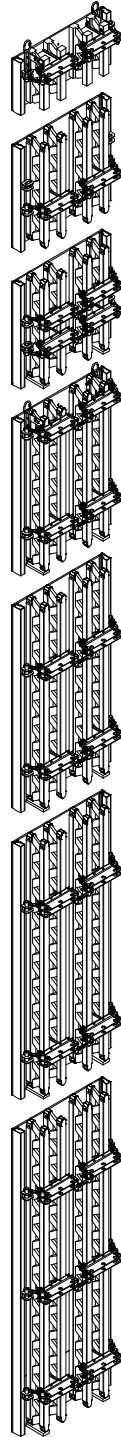

| Item no. | Weight kg |
|----------|-----------|
| 020820   | 91.300    |
| 126079   | 120.000   |
| 020840   | 136.000   |
| 020860   | 175.000   |
| 020880   | 203.000   |

**Outside Panels A 85**

**Outside Panel A 85 x 120**

**Outside Panel A 85 x 180**

**Outside Panel A 85 x 240**

**Outside Panel A 85 x 300**

**Outside Panel A 85 x 360**

Ready-to-use formwork panel for circular structures.

**Note**

Element without distribution waler.  
Panel A 85 x 180 complete with crane eye on the left and on the right side.

**Technical Data**

Minimum radius 1.0 m. Plywood 2 x 9 mm.  
Permissible load-bearing point capacity 700 kg with crane sling angle  $\leq 15^\circ$ .

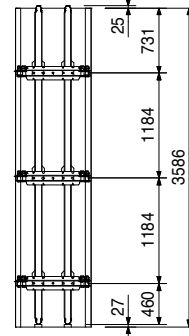
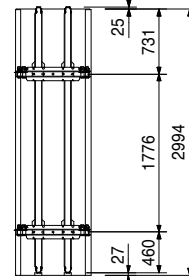
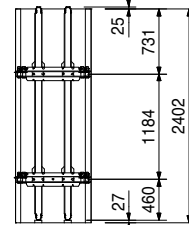
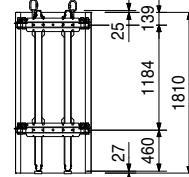
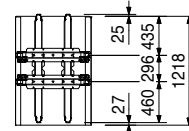
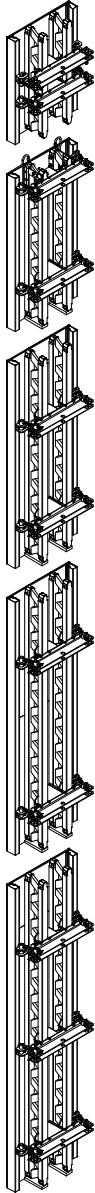

| Item no. | Weight kg |
|----------|-----------|
| 020830   | 74.300    |
| 126070   | 101.000   |
| 020850   | 116.000   |
| 020870   | 153.000   |
| 020890   | 173.000   |

- Inside Panels I 72**
- Inside Panel I 72 x 120**
- Inside Panel I 72 x 180**
- Inside Panel I 72 x 240**
- Inside Panel I 72 x 300**
- Inside Panel I 72 x 360**

Ready-to-use formwork panel for circular structures.

**Note**

Element without distribution waler.  
Panel I 72 x 180 complete with crane eye on the left and on the right side.

**Technical Data**

Minimum radius 1.0 m. Plywood 2 x 9 mm.  
Permissible load-bearing point capacity 700 kg with crane sling angle  $\leq 15^\circ$ .

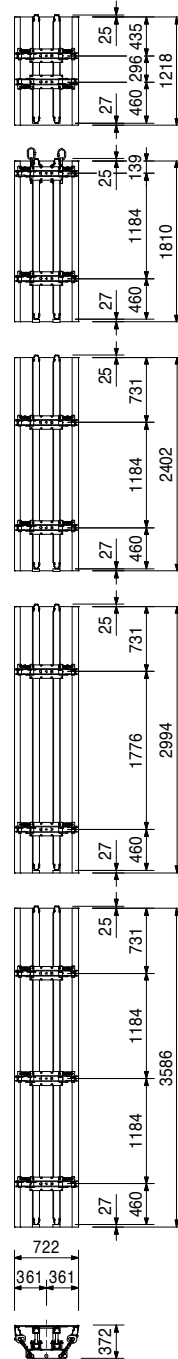
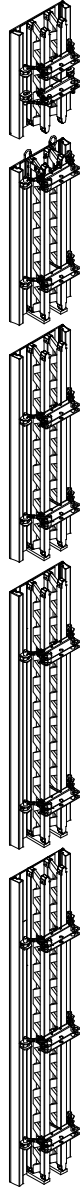

| Item no. | Weight kg |
|----------|-----------|
| 023500   | 4.580     |

**Alignment Coupler BFD, galv.**  
For all panel connections for MAXIMO, TRIO and RUNDFLEX. Fillers up to 10 cm.

**Technical Data**  
Permissible tension force 20.0 kN.

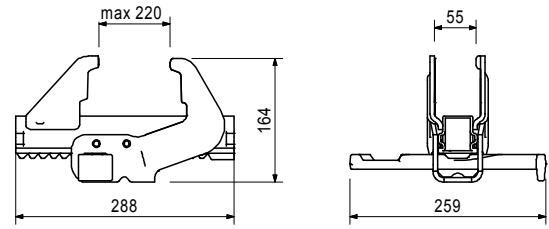
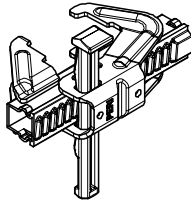

|        |       |
|--------|-------|
| 023940 | 6.080 |
|--------|-------|

**Alignment Coupler 38, galv.**  
For element connections with RUNDFLEX.

**Note**  
Compensation up to 26 cm.  
**Technical Data**  
Permissible tension force 20.0 kN.

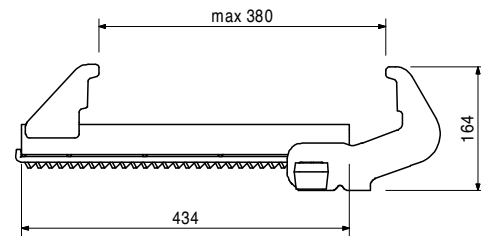
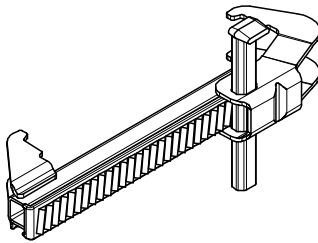

|        |       |
|--------|-------|
| 021620 | 3.770 |
|--------|-------|

**Adjusting Spindle 500, galv.**  
For aligning RUNDFLEX external elements. For panel joints of external and internal elements.

**Complete with**  
2 pc. 022230 Cotter Pin 5/1, galv.  
**Note**  
With self-cleaning hexagonal thread.

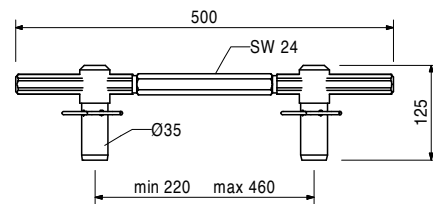
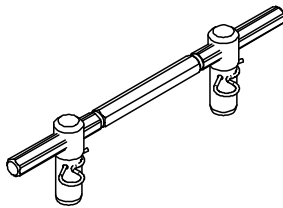

|        |       |
|--------|-------|
| 021610 | 2.830 |
|--------|-------|

**Adjusting Spindle 210, galv.**  
For aligning RUNDFLEX internal elements and the edge profiles on external and internal elements.

**Complete with**  
2 pc. 022230 Cotter Pin 5/1, galv.  
**Note**  
With self-cleaning hexagonal thread.

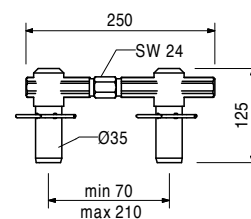
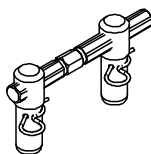

| Item no. | Weight kg |
|----------|-----------|
| 021630   | 18.300    |

### Distribution Waler

For transferring anchor forces on two adjacently positioned T-walers.

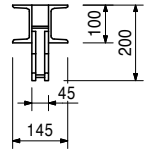
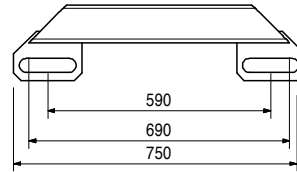
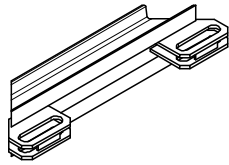

|        |       |
|--------|-------|
| 021640 | 1.260 |
|--------|-------|

Accessories

### Waler Bolt for RUNDFLEX, galv.

|        |       |
|--------|-------|
| 021640 | 1.260 |
|--------|-------|

### Waler Bolt for RUNDFLEX, galv.

For fixing the distribution waler on the T-Waler.

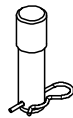

### Complete with

1 pc. 022230 Cotter Pin 5/1, galv.

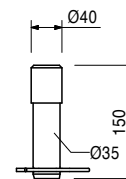

|        |       |
|--------|-------|
| 024480 | 7.040 |
|--------|-------|

### Extension Splice 24-2

For extending GT 24 girders and VARIO GT 24 panels up to max. height of 8.00 m.

### Complete with

2 pc. 030190 Three Wingnut DW 15, galv.

### Note

Permissible load: see PERI Design Tables.

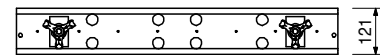
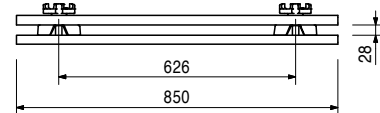

| Item no. | Weight kg |
|----------|-----------|
| 070760   | 4.650     |

### Crane Splice GT 24

For transporting elements by crane with the GT 24 girder.

### Complete with

- 1 pc. 018050 Pin  $\varnothing$  16 x 65/86, galv.
- 2 pc. 018060 Cotter Pin 4/1, galv.

### Note

Follow Instructions for Use!

### Technical Data

Permissible load-bearing capacity 700 kg with crane sling angle  $\leq 15^\circ$ .

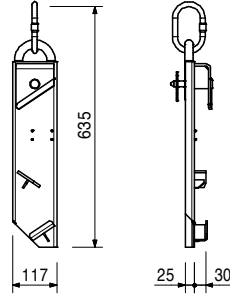
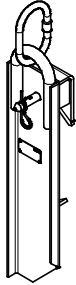

|        |       |
|--------|-------|
| 021990 | 2.780 |
| 021980 | 2.780 |

### Crane Eyes 24

#### Crane Eye 24, right

#### Crane Eye 24, left

For transporting elements by crane with the GT 24 girder. Mounted securely to the element.

### Complete with

- 4 pc. 710138 Bolt ISO 4014 M10 x 110-8.8, galv.
- 4 pc. 780356 Nut ISO 7042 M10-8, galv.
- 4 pc. 710139 Washer R11 DIN 440, galv.

### Note

Illustration shows Crane Eye 24, left. Follow Instructions for Use!

### Technical Data

Permissible load-bearing capacity 700 kg with crane sling angle  $\leq 15^\circ$ .

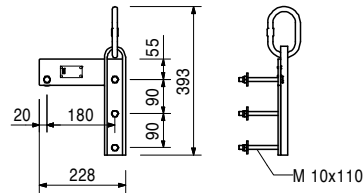
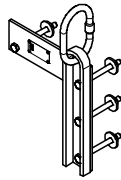

|        |        |
|--------|--------|
| 027110 | 11.000 |
|--------|--------|

### Scaffold Bracket GB 80

For assembly of a working and concreting scaffold with GT 24 girder.

### Technical Data

Permissible load 150 kg/m<sup>2</sup>. Maximum width of influence 1.25 m.

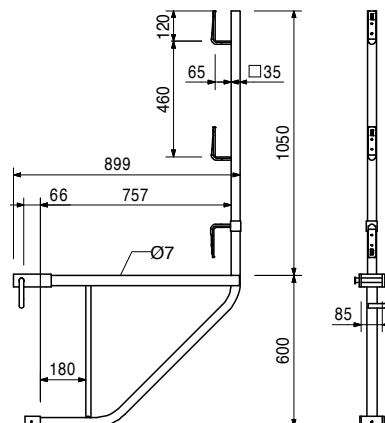
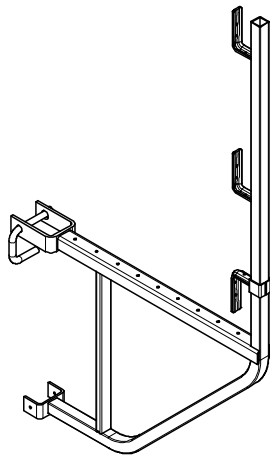



| Item no. | Weight kg |
|----------|-----------|
| 112159   | 2.120     |

**Handrail Post Holder VARIO**  
For assembling a guardrail with GT 24 Girder.

**Complete with**  
1 pc. 024250 Wedge K, galv.  
1 pc. 780800 Sleeve ISO 8752 8 x 20, galv.  
**Technical Data**  
Maximum width of influence 2.00 m.

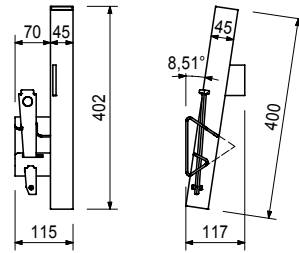
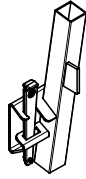

Accessories

|        |       |
|--------|-------|
| 116292 | 4.730 |
|--------|-------|

**Guardrail Post HSGP-2**

|        |       |
|--------|-------|
| 116292 | 4.730 |
|--------|-------|

**Guardrail Post HSGP-2**  
As guardrail for different systems.

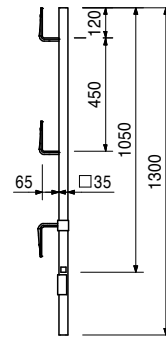

|        |       |
|--------|-------|
| 021790 | 1.000 |
|--------|-------|

**Ratchet Spanner SW 24 "Combi"**  
For adjusting RUNDFLEX Panels and Cantilevered Parapet Platform GKB.

**Note**  
Length approx. 500 mm.

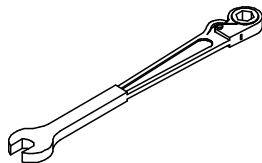

|        |       |
|--------|-------|
| 099540 | 0.000 |
| 098217 | 0.000 |

**Templates for RUNDFLEX**  
**Template for RUNDFLEX A250, I240, A128, I123**  
**Template for RUNDFLEX A85, I72**  
The template is used for external and internal elements.

**Note**  
Including material (formlining). Produced in accordance with project requirements.

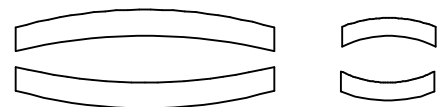

| Item no. | Weight kg |
|----------|-----------|
| 109411   | 6.450     |

### Ladder Connector RFP

For connecting ladders at RUNDFLEX Plus and RUNDFLEX panels.

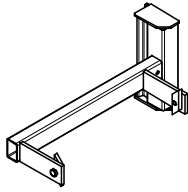

### Complete with

2 pc. 710266 Bolt ISO 4017 M12 x 25-8.8, galv.  
2 pc. 701763 Clamping Plate FI 25 x 10 x 90

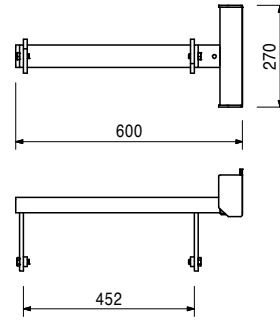

|        |        |
|--------|--------|
| 051410 | 11.700 |
|--------|--------|

### Ladder 180/6, galv.

As access for PERI Formwork Systems.

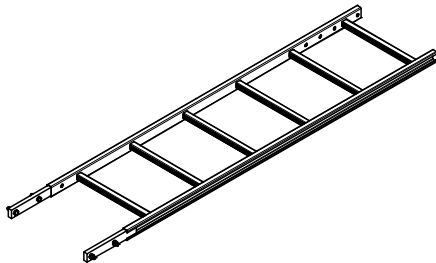

### Complete with

4 pc. 710224 Bolt ISO 4017 M12 x 40-8.8, galv.  
4 pc. 710381 Nut ISO 7042 M12-8, galv.

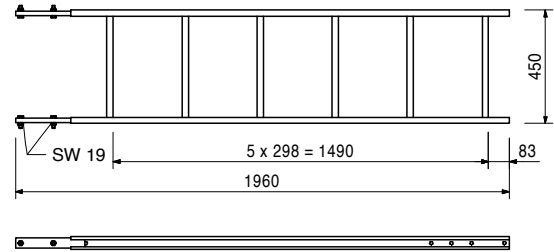

|        |       |
|--------|-------|
| 051460 | 2.180 |
|--------|-------|

### Ladder Base, galv.

As bottom ladder connection and for securing ladders against sliding on the scaffold decks.

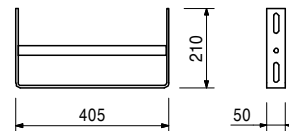
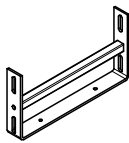

|        |       |
|--------|-------|
| 103718 | 0.684 |
|--------|-------|

### Ladder Hook, galv.

For adjusting the bottom ladder.  
Always use in pairs.



### Complete with

2 pc. 710266 Bolt ISO 4017 M12 x 25-8.8, galv.  
2 pc. 710381 Nut ISO 7042 M12-8, galv.

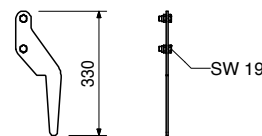

Item no. Weight kg

|        |        |
|--------|--------|
| 104132 | 15.600 |
| 051450 | 25.200 |

**Ladder Safety Cages, galv.**  
**Ladder Safety Cage 75, galv.**  
**Ladder Safety Cage 150, galv.**  
 Ladder safety cage for PERI Access Ladders.

**Complete with**  
 4 pc. 710266 Bolt ISO 4017 M12 x 25-8.8, galv.  
 4 pc. 701763 Clamping Plate FI 25 x 10 x 90

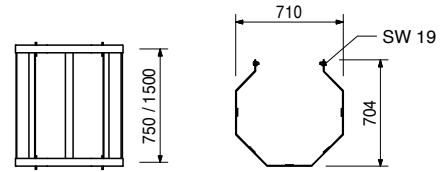
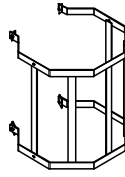

109420 27.000

**Ladder Safety Cage RFP 200**  
 Ladder safety cage for access ladders with exit on the side.

**Complete with**  
 4 pc. 710266 Bolt ISO 4017 M12 x 25-8.8, galv.  
 4 pc. 701763 Clamping Plate FI 25 x 10 x 90

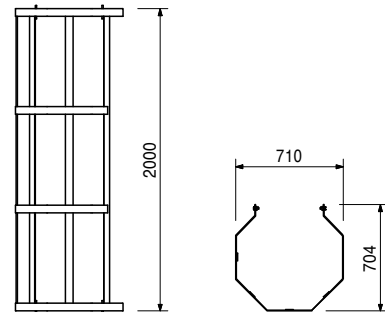
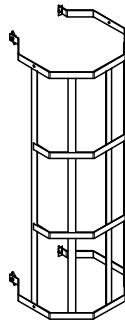

028050 4.550

**Girder Headpiece GT 24, galv.**  
 For connecting push-pull props and kicker braces to GT 24 Girders

**Complete with**  
 1 pc. 027170 Pin Ø 16 x 42, galv.  
 1 pc. 018060 Cotter Pin 4/1, galv.

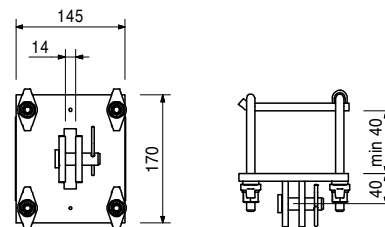
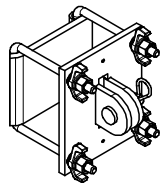

028070 4.680

**Girder Headpiece GT 24/A, galv.**  
 For connecting push-pull props and kicker braces to extended GT 24 Girders in the area of the Extension Splice 24-2.

**Complete with**  
 1 pc. 027170 Pin Ø 16 x 42, galv.  
 1 pc. 018060 Cotter Pin 4/1, galv.

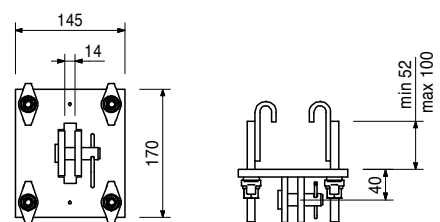
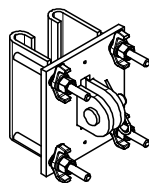

| Item no. | Weight kg |
|----------|-----------|
| 028060   | 1.940     |

### Wedge Headpiece SRZ/SRU

For connecting push-pull props and kicker braces to Steel Waler SRZ and SRU Profile U100 – U140.

### Complete with

1 pc. 027170 Pin  $\varnothing$  16 x 42, galv.  
1 pc. 018060 Cotter Pin 4/1, galv.

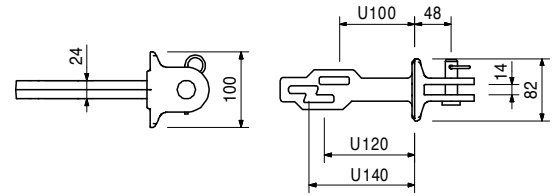
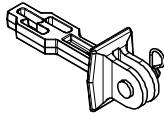

### Accessories

|        |       |
|--------|-------|
| 024250 | 0.331 |
|--------|-------|

### Wedge K, galv.

|        |       |
|--------|-------|
| 024250 | 0.331 |
|--------|-------|

### Wedge K, galv.

For coupling Compression Plate KDP, Wedge Head Piece SRZ/SRU and Waler Connector SB-A, B, C.

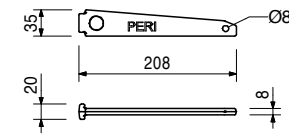

|        |        |
|--------|--------|
| 117466 | 10.600 |
|--------|--------|

### Push-Pull Prop RS 210, galv.

Extension length  $l = 1.30 - 2.10$  m.  
For aligning PERI formwork systems and precast concrete elements.

### Note

Permissible load see PERI Design Tables.

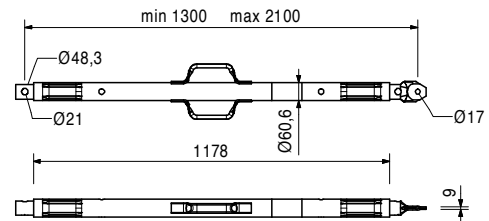
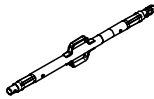

|        |        |
|--------|--------|
| 118238 | 12.200 |
|--------|--------|

### Push-Pull Prop RS 260, galv.

Extension length  $l = 2.30 - 2.60$  m.  
For aligning PERI formwork systems and precast concrete elements.

### Note

Permissible load see PERI Design Tables.

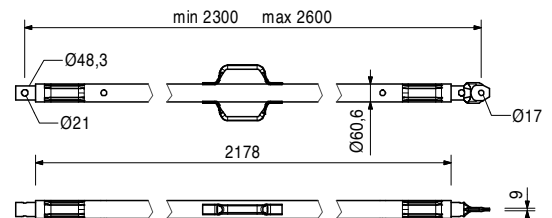
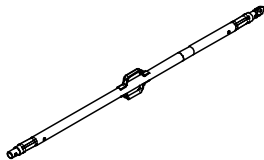

| Item no. | Weight kg |
|----------|-----------|
| 117467   | 15.500    |

**Push-Pull Prop RS 300, galv.**

Extension length  $l = 1.90 - 3.00$  m.  
For aligning PERI formwork systems and precast concrete elements.

**Note**

Permissible load see PERI Design Tables.

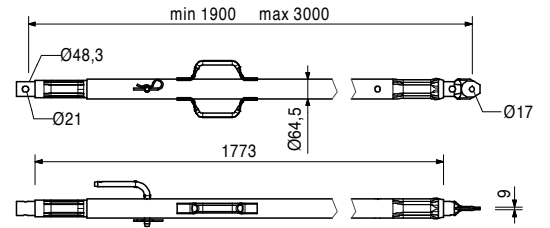
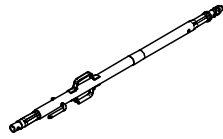

|        |        |
|--------|--------|
| 117468 | 23.000 |
|--------|--------|

**Push-Pull Prop RS 450, galv.**

Extension length  $l = 2.80 - 4.50$  m.  
For aligning PERI formwork systems and precast concrete elements.

**Note**

Permissible load see PERI Design Tables.

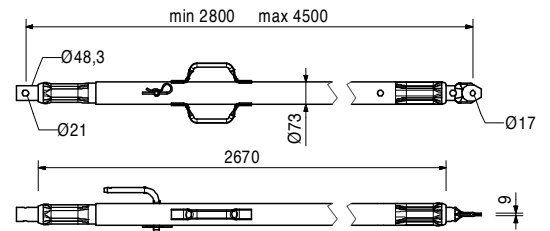
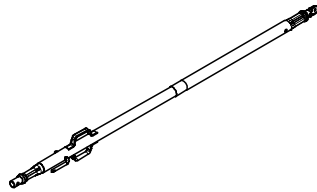

|        |        |
|--------|--------|
| 117469 | 40.000 |
|--------|--------|

**Push-Pull Prop RS 650, galv.**

Extension length  $l = 4.30 - 6.50$  m.  
For aligning PERI formwork systems and precast concrete elements.

**Note**

Permissible load see PERI Design Tables.

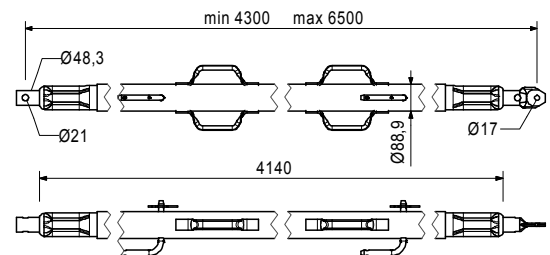
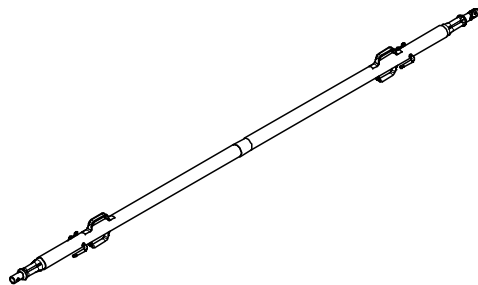

|        |         |
|--------|---------|
| 028990 | 115.000 |
|--------|---------|

**Push-Pull Prop RS 1000, galv.**

Extension length  $l = 6.40 - 10.00$  m.  
For aligning PERI formwork systems.

**Note**

Permissible load see PERI Design Tables.

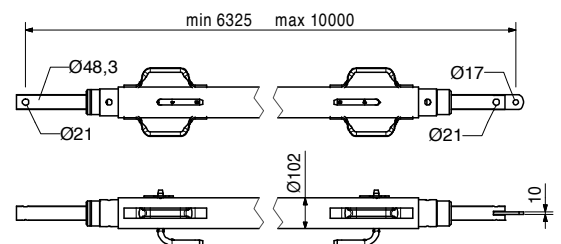
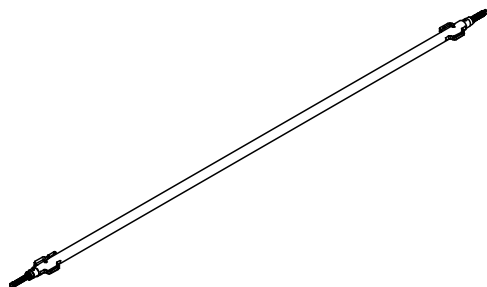

| Item no. | Weight kg |
|----------|-----------|
| 103800   | 271.000   |

## Push-Pull Prop RS 1400, galv.

Extension length  $l = 6.40 - 14.00$  m.  
For aligning PERI formwork systems.

### Note

Permissible load see PERI Design Tables.  
Chain can be operated from bottom.

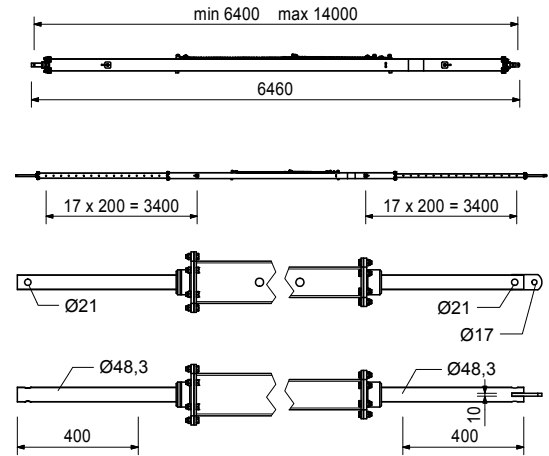
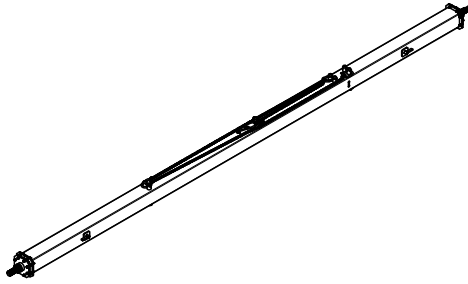

|        |       |
|--------|-------|
| 117343 | 3.250 |
|--------|-------|

## Base Plate-2 for RS 210 - 1400, galv.

For assembly of Push-Pull Props RS 210, 260, 300, 450, 650, 1000 and 1400.

### Complete with

2 pc. 105400 Pin  $\varnothing 20 \times 140$ , galv.  
2 pc. 018060 Cotter Pin 4/1, galv.

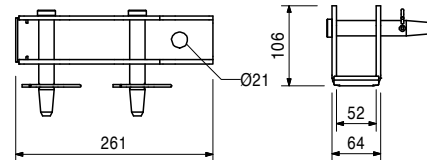
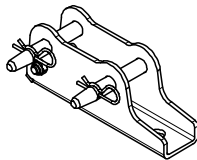

Accessories

|        |       |
|--------|-------|
| 124777 | 0.210 |
|--------|-------|

## Anchor Bolt PERI 14/20 x 130

|        |       |
|--------|-------|
| 126666 | 3.070 |
|--------|-------|

## Base Plate-3 for RS 210 - 1400

For assembly of Push-Pull Props RS 210, 260, 300, 450, 650, 1000 and 1400.

### Complete with

2 pc. 105400 Pin  $\varnothing 20 \times 140$ , galv.  
2 pc. 018060 Cotter Pin 4/1, galv.  
1 pc. 113063 Bolt ISO 4014 M12 x 80-8.8, galv.  
1 pc. 113064 Hex Nut ISO7042-M12-8-G, galv.

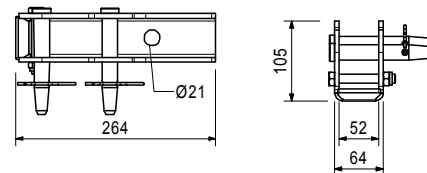
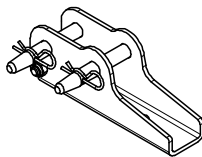

Accessories

|        |       |
|--------|-------|
| 124777 | 0.210 |
|--------|-------|

## Anchor Bolt PERI 14/20 x 130

| Item no. | Weight kg |
|----------|-----------|
| 028010   | 17.900    |

### Push-Pull Prop RSS I

Extension length  $l = 2.05 - 2.94$  m.  
For aligning PERI formwork systems.

### Note

Permissible load see PERI Design Tables.

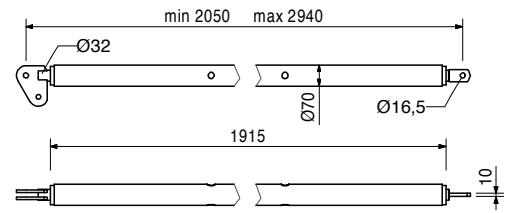
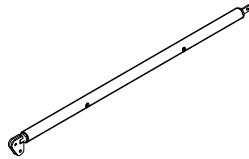

|        |       |
|--------|-------|
| 113397 | 1.600 |
|--------|-------|

### Spindle Handle RSS / AV

Spindle Handle for screwing on Push-Pull-Props RSS I, RSS II, RSS III and Kickers AV 210 and AV 190 complete with 2 bolts and nuts M8.

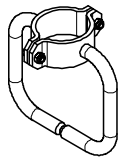
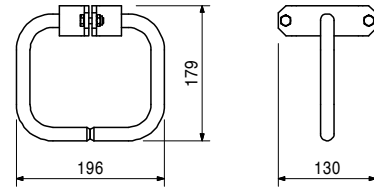

|        |        |
|--------|--------|
| 028020 | 22.000 |
|--------|--------|

### Push-Pull Prop RSS II

Extension length  $l = 2.91 - 3.80$  m.  
For aligning PERI formwork systems.

### Note

Permissible load see PERI Design Tables.

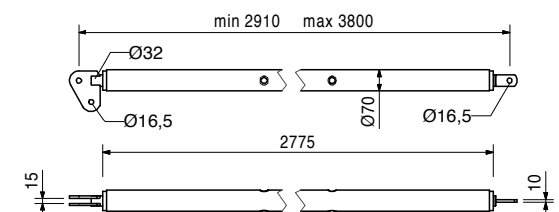
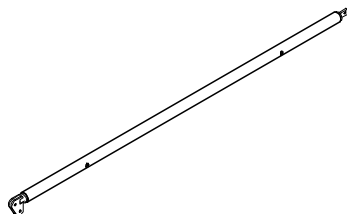

|        |        |
|--------|--------|
| 028030 | 38.400 |
|--------|--------|

### Push-Pull Prop RSS III

Extension length  $l = 4.60 - 6.00$  m.  
For aligning PERI formwork systems.

### Note

Permissible load see PERI Design Tables.

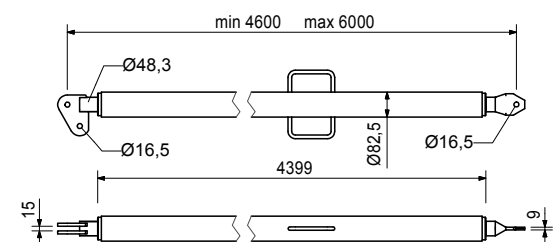
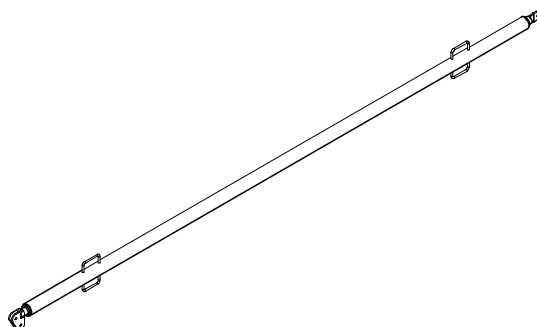

| Item no. | Weight kg |
|----------|-----------|
| 106000   | 1.820     |

**Base Plate-2 for RSS, galv.**  
For assembly of RSS Push-Pull Props.

**Complete with**  
1 pc. 027170 Pin Ø 16 x 42, galv.  
1 pc. 018060 Cotter Pin 4/1, galv.

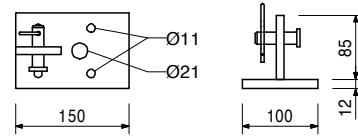
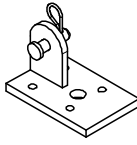

Accessories  
**Anchor Bolt PERI 14/20 x 130**

|        |       |
|--------|-------|
| 124777 | 0.210 |
|--------|-------|

| Kickers AV |       |
|------------|-------|
| 057087     | 3.720 |
| 057088     | 4.410 |

**Kicker AV 82**  
**Kicker AV 111**  
For aligning PERI formwork systems.

| min. L | max. L |
|--------|--------|
| 500    | 820    |
| 790    | 1110   |

**Complete with**  
1 pc. 027170 Pin Ø 16 x 42, galv.  
1 pc. 018060 Cotter Pin 4/1, galv.  
**Note**  
Permissible load see PERI Design Tables.

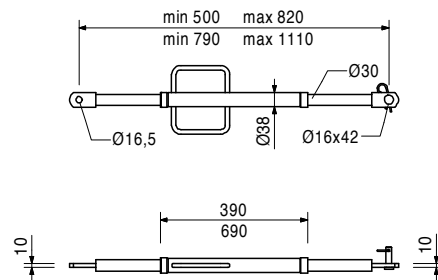
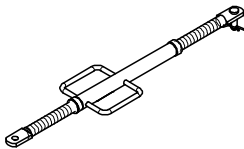

|        |       |
|--------|-------|
| 028110 | 5.180 |
|--------|-------|

**Kicker AV 140**  
Extension length l = 1.08 – 1.40 m.  
For aligning PERI formwork systems.

**Complete with**  
1 pc. 027170 Pin Ø 16 x 42, galv.  
1 pc. 018060 Cotter Pin 4/1, galv.  
**Note**  
Permissible load see PERI Design Tables.

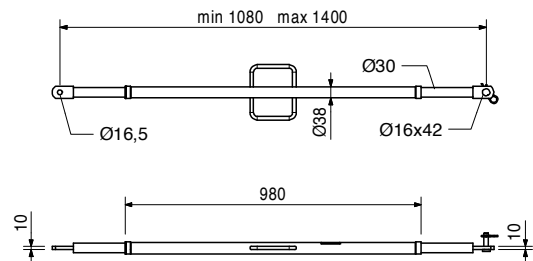
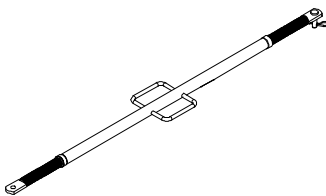



# RUNDFLEX Circular Formwork



| Item no. | Weight kg |
|----------|-----------|
| 108135   | 12.900    |

## Kicker AV 210

Extension length  $l = 1.28 - 2.10$  m.  
For aligning PERI formwork systems.

### Complete with

1 pc. 027170 Pin  $\varnothing 16 \times 42$ , galv.  
1 pc. 018060 Cotter Pin 4/1, galv.

### Note

Permissible load see PERI Design Tables.

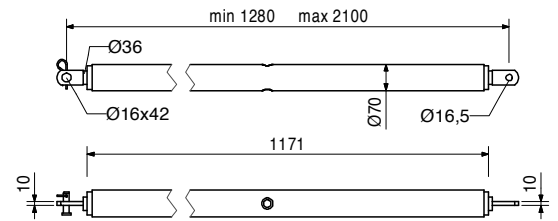
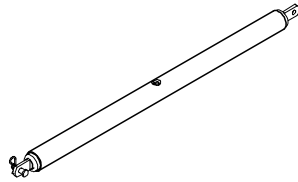

|        |        |
|--------|--------|
| 028120 | 17.000 |
|--------|--------|

## Kicker AV RSS III

Extension length  $l = 2.03 - 2.92$  m.  
For aligning PERI formwork systems.

### Complete with

1 pc. 027170 Pin  $\varnothing 16 \times 42$ , galv.  
1 pc. 018060 Cotter Pin 4/1, galv.

### Note

Permissible load see PERI Design Tables.

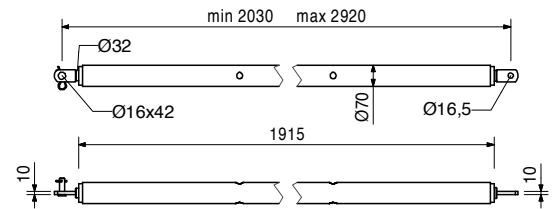
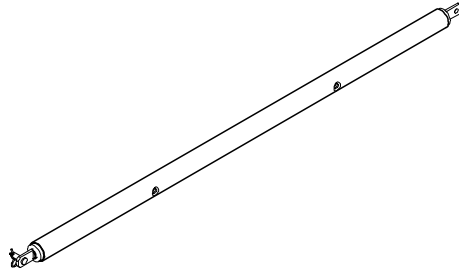

|        |       |
|--------|-------|
| 124777 | 0.210 |
|--------|-------|

## Anchor Bolt PERI 14/20 x 130

For temporary fixation to reinforced concrete structures.

### Note

See PERI data sheet!  
Drilling  $\varnothing 14$  mm.

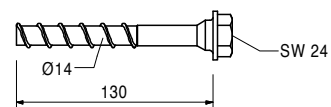
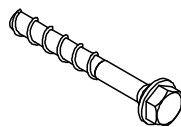

# PERI International

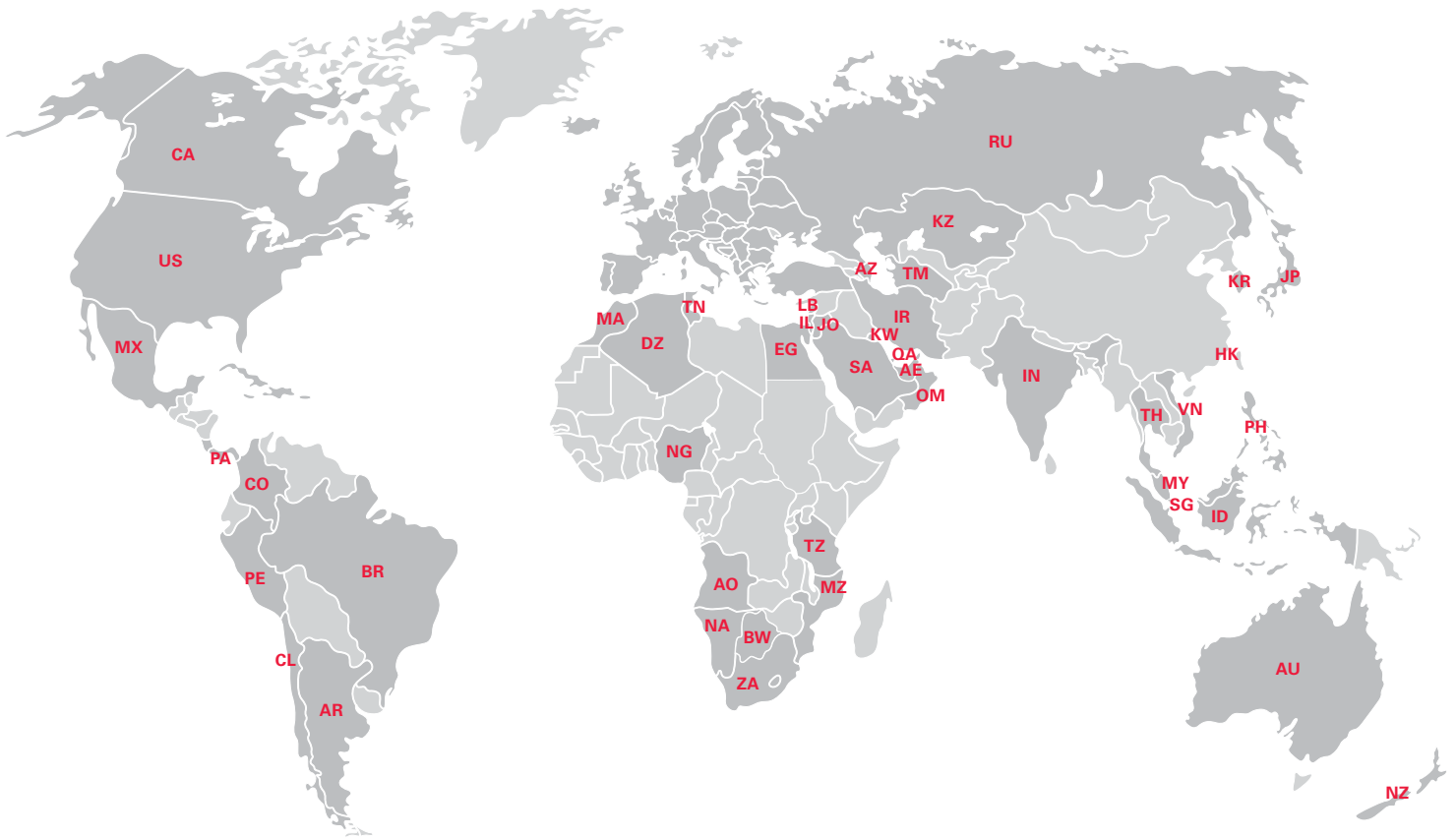

## North America

- CA** Canada  
PERI Formwork Systems, Inc.  
[www.peri.ca](http://www.peri.ca)
- MX** Mexico  
PERI Cimbras y Andamios, S.A. de C.V.  
[www.peri.com.mx](http://www.peri.com.mx)
- PA** Panama  
PERI Panama Inc.  
[www.peri.com.pa](http://www.peri.com.pa)
- US** USA  
PERI Formwork Systems, Inc.  
[www.peri-usa.com](http://www.peri-usa.com)

## South America

- AR** Argentina  
PERI S.A.  
[www.peri.com.ar](http://www.peri.com.ar)
- BR** Brazil  
PERI Formas e Escoramentos Ltda.  
[www.peribrasil.com.br](http://www.peribrasil.com.br)
- CL** Chile  
PERI Chile Ltda.  
[www.peri.cl](http://www.peri.cl)
- CO** Colombia  
PERI S.A.S.  
[www.peri.com.co](http://www.peri.com.co)
- PE** Peru  
PERI Peruana S.A.C.  
[www.peri.com.pe](http://www.peri.com.pe)

## Africa

- AO** Angola  
Pericofragens, Lda.  
[www.peri.pt](http://www.peri.pt)
- DZ** Algeria  
S.A.R.L. PERI  
[www.peri.dz](http://www.peri.dz)
- BW** Botswana  
PERI (Proprietary) Limited  
[www.peri.co.bw](http://www.peri.co.bw)
- EG** Egypt  
Egypt Branch Office  
[www.peri.com.eg](http://www.peri.com.eg)
- MA** Morocco  
PERI S.A.  
[www.peri.ma](http://www.peri.ma)
- MZ** Mozambique  
PERI (Pty.) Ltd.  
[www.peri.co.mz](http://www.peri.co.mz)
- NA** Namibia  
PERI (Pty.) Ltd.  
[www.peri.na](http://www.peri.na)
- NG** Nigeria  
PERI Nigeria Ltd.  
[www.peri.ng](http://www.peri.ng)
- TN** Tunisia  
PERI S.A.U.  
[www.peri.es](http://www.peri.es)
- TZ** Tanzania  
PERI Formwork and Scaffolding Ltd  
[www.peritanzania.com](http://www.peritanzania.com)
- ZA** South Africa  
PERI Formwork Scaffolding (Pty) Ltd  
[www.peri.co.za](http://www.peri.co.za)

## Asia

- AE** United Arab Emirates  
PERI (L.L.C.)  
[www.perime.com](http://www.perime.com)
- AZ** Azerbaijan  
PERI Representative Office  
[www.peri.com.tr](http://www.peri.com.tr)
- HK** Hong Kong  
PERI (Hong Kong) Limited  
[www.perihk.com](http://www.perihk.com)
- ID** Indonesia  
PT Beton Perkasa Wijaksana  
[www.betonperkasa.com](http://www.betonperkasa.com)
- IL** Israel  
PERI F.E. Ltd.  
[www.peri.co.il](http://www.peri.co.il)
- IN** India  
PERI (India) Pvt Ltd  
[www.peri.in](http://www.peri.in)
- IR** Iran  
PERI Persa. Ltd.  
[www.peri.ir](http://www.peri.ir)
- JO** Jordan  
PERI GmbH – Jordan  
[www.peri.com](http://www.peri.com)
- JP** Japan  
PERI Japan K.K.  
[www.perijapan.jp](http://www.perijapan.jp)
- KR** Korea  
PERI (Korea) Ltd.  
[www.perikorea.com](http://www.perikorea.com)
- KW** Kuwait  
PERI Kuwait W.L.L.  
[www.peri.com.kw](http://www.peri.com.kw)
- KZ** Kazakhstan  
TOO PERI Kazakhstan  
[www.peri.kz](http://www.peri.kz)
- LB** Lebanon  
PERI Lebanon Sarl  
[lebanon@peri.de](mailto:lebanon@peri.de)
- MY** Malaysia  
PERI Formwork Malaysia Sdn. Bhd.  
[www.perimalaysia.com](http://www.perimalaysia.com)
- OM** Oman  
PERI (L.L.C.)  
[www.perime.com](http://www.perime.com)
- PH** Philippines  
PERI-Asia Philippines, INC.  
[www.peri.com.ph](http://www.peri.com.ph)
- QA** Qatar  
PERI Qatar LLC  
[www.peri.qa](http://www.peri.qa)
- SA** Saudi Arabia  
PERI Saudi Arabia Ltd.  
[www.peri.com.sa](http://www.peri.com.sa)
- SG** Singapore  
PERI Asia Pte Ltd  
[www.periasia.com](http://www.periasia.com)
- TM** Turkmenistan  
PERI Kalıp ve İşkeleleri  
[www.peri.com.tr](http://www.peri.com.tr)
- TH** Thailand  
Peri (Thailand) Co., Ltd.  
[www.peri.co.th](http://www.peri.co.th)
- VN** Vietnam  
PERI ASIA PTE LTD  
[www.peri.com.vn](http://www.peri.com.vn)



**PERI GmbH**  
**Formwork Scaffolding Engineering**  
Rudolf-Diesel-Strasse 19  
89264 Weissenhorn  
Germany  
Tel. +49 (0)7309.950-0  
Fax +49 (0)7309.951-0  
info@peri.com  
www.peri.com



## Oceania

**AU** Australia  
PERI Australia Pty. Ltd.  
www.periaus.com.au

**NZ** New Zealand  
PERI Australia Pty. Limited  
www.peri.co.nz

## Europe

**AL** Albania  
PERI Kalıp ve İskeleleri  
www.peri.com.tr

**AT** Austria  
PERI Ges.mbH  
www.peri.at

**BA** Bosnia and Herzegovina  
PERI oplate i skele d.o.o  
www.peri.com.hr

**BE** Belgium  
N.V. PERI S.A.  
www.peri.be

**BG** Bulgaria  
PERI Bulgaria EOOD  
www.peri.bg

**BY** Belorussia  
IOOO PERI  
www.peri.by

**CH** Switzerland  
PERI AG  
www.peri.ch

**CZ** Czech Republic  
PERI spol. s r.o.  
www.peri.cz

**DE** Germany  
PERI GmbH  
www.peri.de

**DK** Denmark  
PERI Danmark A/S  
www.peri.dk

**EE** Estonia  
PERI AS  
www.peri.ee

**ES** Spain  
PERI S.A.U.  
www.peri.es

**FI** Finland  
PERI Suomi Ltd. Oy  
www.perisuomi.fi

**FR** France  
PERI S.A.S.  
www.peri.fr

**GB** United Kingdom  
PERI Ltd.  
www.peri.ltd.uk

**GR** Greece  
PERI Hellas Ltd.  
www.perihellas.gr

**HR** Croatia  
PERI oplate i skele d.o.o.  
www.peri.com.hr

**HU** Hungary  
PERI Kft.  
www.peri.hu

**IR** Ireland  
Siteserv Access & Formwork  
www.siteservaccess.ie

**IS** Iceland  
Armar ehf.  
www.armor.is

**IT** Italy  
PERI S.r.l.  
www.peri.it

**LT** Lithuania  
PERI UAB  
www.peri.lt

**LU** Luxembourg  
N.V. PERI S.A.  
www.peri.lu

**LV** Latvia  
PERI SIA  
www.peri-latvija.lv

**NL** Netherlands  
PERI B.V.  
www.peri.nl

**NO** Norway  
PERI Norge AS  
www.peri.no

**PL** Poland  
PERI Polska Sp. z o.o.  
www.peri.com.pl

**PT** Portugal  
Pericofragens Lda.  
www.peri.pt

**RO** Romania  
PERI România SRL  
www.peri.ro

**RS** Serbia  
PERI oplate d.o.o.  
www.peri.rs

**RU** Russia  
OOO PERI  
www.peri.ru

**SE** Sweden  
PERI Sverige AB  
www.peri.se

**SI** Slovenia  
PERI oplate i skele d.o.o  
www.peri.com.hr

**SK** Slovakia  
PERI spol. s. r.o.  
www.peri.sk

**TR** Turkey  
PERI Kalıp ve İskeleleri  
www.peri.com.tr

**UA** Ukraine  
TOW PERI  
www.peri.ua

**The optimal System  
for every Project and  
every Requirement**



**Wall Formwork**



**Column Formwork**



**Slab Formwork**



**Climbing Systems**



**Bridge Formwork**



**Tunnel Formwork**



**Shoring Systems**



**Construction Scaffold**



**Facade Scaffold**



**Industrial Scaffold**



**Access**



**Protection Scaffold**



**Safety Systems**



**System-Independent Accessories**



**Services**



**PERI GmbH**  
**Formwork Scaffolding Engineering**  
 Rudolf-Diesel-Strasse 19  
 89264 Weissenhorn  
 Germany  
 Tel. +49 (0) 7309.950-0  
 Fax +49 (0) 7309.951-0  
 info@peri.com  
 www.peri.com